

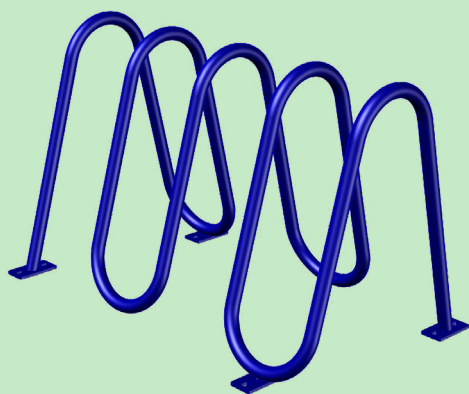

# Ripple Rack

## Product Outline

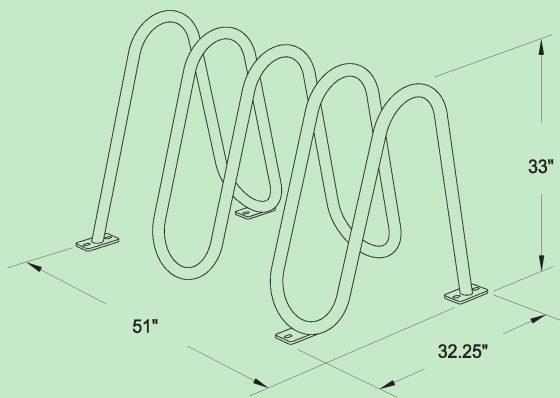



### Parking Capacity

3-5 

### Materials

1.66" OD

### Finishes

-  Powder Coat (over high strength steel)  
Electrostatically applied powder finish over zinc-rich primer.
-  Stainless Steel  
304 grade stainless steel with varying surface finishes available from gloss to satin.

### Mounting Options

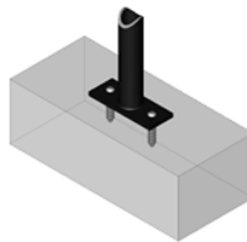

-  Surface  
Base plates are anchored directly to the concrete using tamper proof anchors. Greenspoke includes the hardware required but there are several other hardware options also available.  
Typical anchor hardware:  
1/2" security bolt  
1/2" drop-in anchor (with setting tool)