

M-Rack

Product Outline

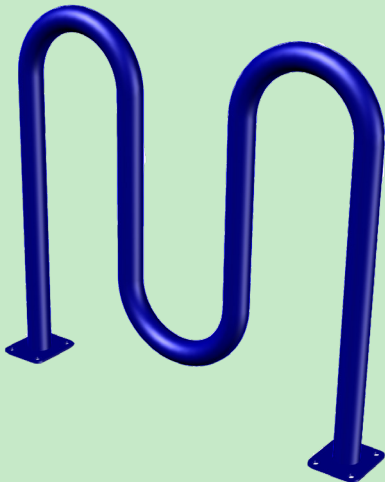

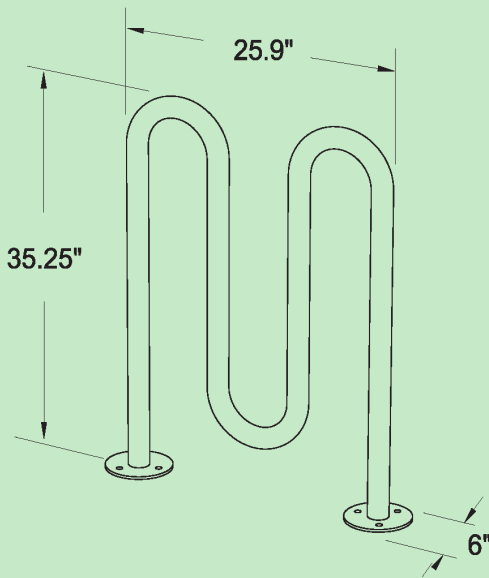

Parking Capacity

2 

Materials

2.375" OD

Finishes

-  Powder Coat (over high strength steel)
Electrostatically applied powder finish over zinc-rich primer.
-  Stainless Steel
304 grade stainless steel with varying surface finishes available from gloss to satin.

Mounting Options

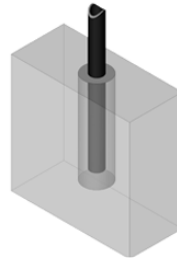

-  In-ground
 - Embedded in concrete footings
 - Detailed instruction provided for each rack

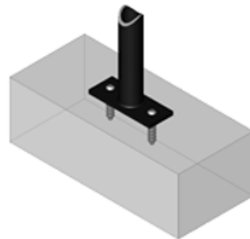

-  Surface
 - Base plates are anchored directly to the concrete using tamper proof anchors. Greenspoke includes the hardware required but there are several other hardware options also available.
 - Typical anchor hardware:
 - 1/2" security bolt
 - 1/2" drop-in anchor (with setting tool)