

# Corkscrew

## Product Outline

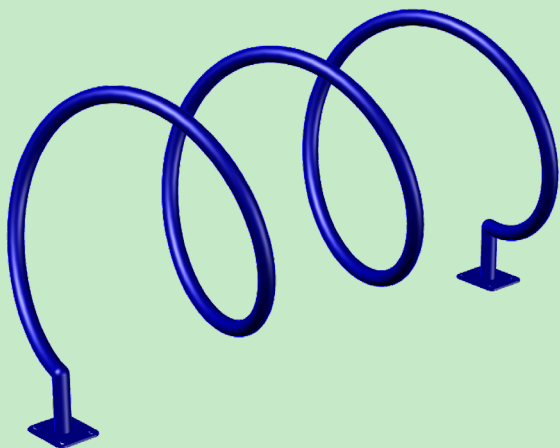

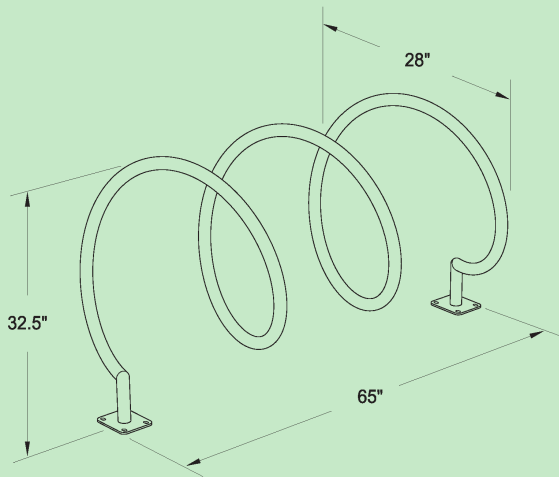

### Parking Capacity

6 

### Materials

1.66" OD

### Finishes

-  Powder Coat (over high strength steel)  
Electrostatically applied powder finish over zinc-rich primer.
-  Stainless Steel  
304 grade stainless steel with varying surface finishes available from gloss to satin.

### Mounting Options

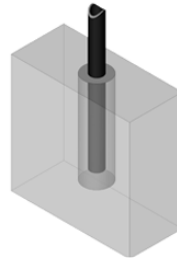

-  In-ground
  - Embedded in concrete footings
  - Detailed instruction provided for each rack

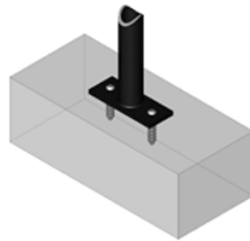

-  Surface
  - Base plates are anchored directly to the concrete using tamper proof anchors. Greenspoke includes the hardware required but there are several other hardware options also available. Typical anchor hardware:
    - 1/2" security bolt
    - 1/2" drop-in anchor (with setting tool)